



PARTS CATALOGUE 2021

17 Adi Dassler Way, Paris, ON, N3L 0B9

info@curtainsider.ca

Ph: 1-519-753-8686





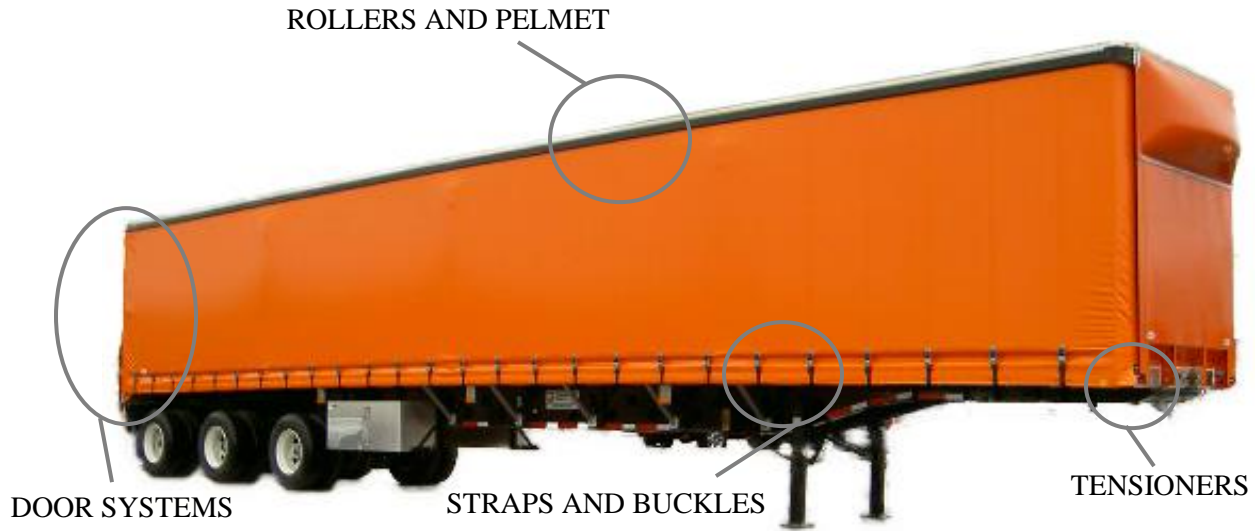





www.curtainsider.ca

2021
REV 7



Buckles and Parts	2
Curtain Straps: Lower and Complete.....	3
Bobbin Rollers and Rings	4
Shielded Greased Bearing Wheels.....	5
Curtain Poles.....	6
Liftout Pillars	8
Rolling Pillars and Parts.....	9
Pelmet	11
Door Hardware.....	12
Tensioners.....	13
Specialty Lighting.....	18
Eyelets, Curtain Material, and Glue.....	19
Replacement Curtains	20
Curtain Graphics	21

**NOT ALL PARTS AVAILABLE MAY BE IN THIS CATALOGUE.
PLEASE CONTACT US FOR MORE INFORMATION.**

<p><u>S/Steel Buckle Spring</u> CSB1004 Tautliner</p> 	 <p><u>S/Steel Buckle</u> CSB1003 Tautliner</p>	 <p><u>S/Steel Buckle</u> CSB1006 Push Release</p>	 <p><u>S/Steel Buckle</u> CSB1008 Over Center, No Spring</p>
<p><u>S/Steel Buckle Lever</u> CSB1005 Tautliner</p> 			
<p><u>Black Plastic Shroud</u> CSB1010 Includes Caps</p> 	<p><u>Stud Plate</u> CSB1011 40mm (Includes Nuts) For CSB1010</p> 	<p><u>Stainless Steel Stud Plate Cover</u> CSB1016 28mm 6mm holes, 2 holes No Studs</p> 	<p><u>Standard Stud Plate</u> CSB1009 28mm x 15mm M6 Studs (Includes Nuts)</p> 
 <p><u>Buckle Fastening Strap</u> CSB1012 Stock Black</p>			

Curtain Straps

STRAP COLOUR CHOICES



LOWER STRAPS

 <p><u>Claw Hook</u> CSB1029-30 (30in) CSB1029-36 (36in) CSB1026 (Claw Hook Only) SPECIFY COLOUR</p>	 <p><u>Rave Hook</u> CSB1022-30 (30in) CSB1022-36 (36in) CSB1022-25 (25in) CSB1028 (Rave Hook Only) SPECIFY COLOUR</p>	 <p><u>Ferry Hook</u> CSB1031-30 (30in) CSB1031-40 (40in) CSB1027 (Ferry Hook Only) SPECIFY COLOUR</p>
---	--	--

 <p><u>Curtain Strap Complete Kit CSB1019-COLOUR</u> (One CSB1003 buckle, one CSB1016 Cover Plate, one CSB1009 Stud Plate, 11' Upper Strap, and one 30" lower strap with rave hook) SPECIFY COLOUR</p>	 <p><u>Curtain Strap Complete Kit CSB1032-COLOUR</u> (One CSB1006 buckle, one CSB1016 Cover Plate, one CSB1009 Stud Plate, 11' Upper Strap, and one 30" lower strap with rave hook) SPECIFY COLOUR</p>	 <p><u>Curtain Strap Complete Kit CSB1033-COLOUR</u> (One CSB1008 buckle, one CSB1016 Cover Plate, one CSB1009 Stud Plate, 11' Upper Strap, and one 30" lower strap with rave hook) SPECIFY COLOUR</p>
---	--	--

NOTE: When ordering the lower strap, include part number, length, and colour. i.e. CSB1022-30-BLK

**Custom straps available upon request.
Allow 2 to 3 days to fabricate orders.**

Bobbin Rollers and Rings

 <p><u>Roller - Bobbin</u> CSB1064 1.220in / 31mm Dia. 1.090in / 27.7mm Wide (BLUE / SQUARE)</p>	 <p><u>Roller - Bobbin</u> CSB1045 1.360in / 34.5mm Dia. 1.325in / 33.5mm Wide (BLACK / SQUARE)</p>	 <p><u>Roller - Bobbin</u> CSB1042 1.450in / 36.85mm Dia. 1.180in / 30mm Wide (GREY / SQUARE)</p>	
 <p><u>Roller - Bobbin</u> CSB1065 1.390in / 35.4mm Dia. 1.450in / 36.8mm Wide (RED / SQUARE)</p>	 <p><u>Roller - Bobbin</u> CSB1039 1.161in / 29.5mm Dia. 1.161in / 29.5mm Wide (BROWN / SQUARE)</p>	 <p><u>Roller - Bobbin</u> CSB1038 1.230in / 31.2mm Dia. 0.920in / 23.4mm Wide (WHITE / SQUARE)</p>	
 <p><u>Roller - Bobbin</u> CSB1048 1.375in / 35mm Dia. 1.225in / 31.1mm Wide (GREEN / TAPERED)</p>	 <p><u>Narrow Waisted Ring</u> CSB1041</p>	 <p><u>Wide Waisted Ring</u> CSB1040</p>	
 <p><u>Wide Waisted Ring</u> CSB1050 White Tab</p>		 <p><u>Wide Waisted Ring</u> CSB1051 Black Tab</p>	

Shielded Greased Bearing Wheels



Square Roller
CSB1283 - 33mm Dia. x 24mm Wide
 Fits Curtainsider Pre 2016



Square Bar Roller
CSB1284 - 37.5mm Dia. x 29mm Wide
 Fits Curtainsider 2016 and on,
 Tag, Canning, Transtech.



Tapered Roller
CSB1285 - 35mm Dia. x 29mm Wide
 Tapered Fits Aerokit, Durabody, Western Morgan



Square Roller
CSB1282 - 33mm Dia. x 31mm Wide
CSB1286 - Discontinued &
 Replaced with CSB1282



Weldable 2in PVC Webbing
CSB1015-STR
 9in Black Punched Tab for Rollers





Tapered Bar Roller
CSB1287 - 35mm Dia. x 29mm Wide

Curtain Poles







 <p><u>Curtain Pole</u> CSB1121-SQ Pole (1 3/8 x 1/8) with Square Drive Welded on Bottom. 120in</p>	 <p><u>Curtain Pole</u> CSB1121-PIN Pole (1 3/8 x 1/8) with 5/16 Pin Welded in Bottom. 120in</p>	 <p><u>Standard</u> <u>Curtain Pole</u> CSB1122-114 18ga GALV. 114in</p>	 <p><u>Pole Cover</u> CSB1131 With 10 pcs RIV6/12LF OR Teck 10/20 x 1/4in</p>
 <p><u>Curtain Pole</u> CSB1185 Round Aluminum Pole (Price Based on 9'-6in OR 114in)</p>	 <p><u>Star Aluminum Curtain Pole</u> CSB1182-100 100in CSB1182-108 108in</p>	 <p><u>Pole Wrapper</u> CSB1020 Top plate welded on. Includes bolts and bottom plate. SPECIFY LEFT/RIGHT</p>	

 <p><u>Alum. Curtain J Pole</u> CSB1186-108: 108in CSB1186-122: 122in CSB1186-244: 244in</p>	  <p><u>Offset Outboard Bottom Pocket</u> CSB1113 For 1.5in square liftout pillar</p>
 <p><u>Aluminum Tensioner Adaptor</u> CSB1184 For CSB1185</p>	 <p><u>Rivet Stainless Steel</u> RIV6/6LF Large Flange 66</p>
 <p><u>Pole Handle</u> CSB1124 Includes x5 Rivet Stainless Steel 66 and Handle Washers</p>	

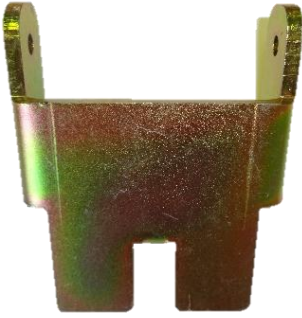
Liftout Pillars

		
<p><u>Complete Liftout Pillar</u> CSB1112 Determine Length. Comes Hot Dipped Galvanized.</p>	<p><u>Liftout Pillar</u> CSB1112-P Post only with CSB1112-T Top.</p>	<p><u>Bottom Handle</u> CSB1112-BP/BT Bottom with Pin (BP) Bottom with Angle Tab (BT) Comes with Handles and Hinge Pin/Washer</p>
<p><u>Top Twist Lock</u> CSB1112-T With "Tee" only. For 1.5in Square Pillar. Bare Steel comes with Gusset</p>		

Rolling Pillars and Parts

 <p><u>Rolling Pillar Sliding Collar</u> CSB1115-19</p>	 <p><u>Rolling Pillar Gravity Swing Lock</u> CSB1115-26</p>	
 <p><u>Rolling Pillar Small Outboard Bracket Assembly</u> CSB1115-24 Galvanized</p>	 <p><u>Rolling Pillar Large Outboard Bracket Assembly</u> CSB1115-23 Galvanized</p>	
 <p><u>Rolling Top Hardware Kit</u> CSB1115-13 Includes Machined Washer, Bolt and Lock Washer</p>  <p>← Replacing</p>	 <p><u>Rolling Pillar Bottom Handle</u> CSB1115-5</p>	 <p><u>Rolling Pillar Top of Post Assembly</u> CSB1115-10 Top of Post Assembly (Slides onto 1x3 Post)</p>

Rolling Pillars and Parts



Roof - Track Stop
CSB1071

Replacing



Steel Rolling Pillar Post
CSB1115-15
1 x 3 x 0.100



**Rolling Pillar -
Top Roller
Bracket**
CSB1115-6
With Rollers
Installed



Rivet Stainless Steel
RIV6/12LF
Large Flange 612



Wafer Head Teck Screw
TEK-WAF-10/24X1.25
Yellow Zinc



Pelmet Plate
CSB1054-ASM
Includes x4 612 S.S. Rivets
OR x4 Wafer Head Teck Screws















Pelmet, or Valance, is used to seal the roof to the top of the curtain. Shown in actual size.

Be sure to check the mating track to ensure proper fit.

Sold by the Roll, per foot.

Door Hardware

 <p><u>Handle Keeper Swivel Latch</u> CSB1116 Galvanized</p>	 <p><u>Shoulder Bushing</u> CSB1102-2</p>	 <p><u>Handle Keeper Base</u> CSB1102 Galvanized</p>
 <p><u>Handle</u> CSB1099</p>	 <p><u>Truss Head Bolt</u> CSB1100 3/8 for Handle (With Thin Nut)</p>	 <p><u>Handle Clip</u> CSB1103 Weld On</p>
<p>CSB1104-R CSB1104-L</p>  <p><u>Single CAM R/L Assembly</u> Includes Mounting Hardware</p>	 <p><u>Weld onto Door Pole Single CAM Base</u> CSB1104-C</p>	 <p><u>Door Stay Retaining Staple</u> CSB1107</p>
 <p><u>Keeper Base for Trailer</u> CSB1101-W Welds to Trailer</p>	 <p><u>Keeper Base for Trailer</u> CSB1101-B Bolts to Trailer</p>	 <p><u>Door Stay Cable Retaining Wire</u> CSB1106</p>

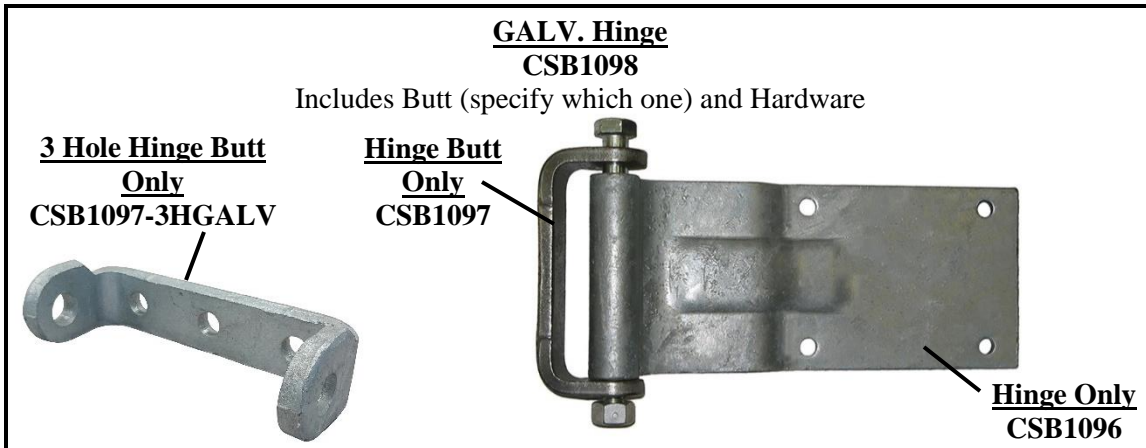

Tensioners, Parts Available Only

** The CSB1159 tensioner is discontinued and being replaced by CSB1197.
Only remaining parts are available, and parts will be discontinued as they run out. **

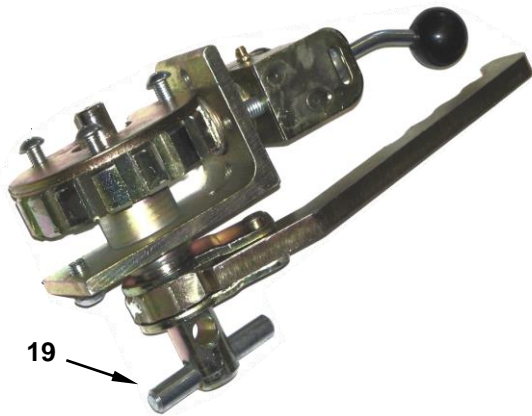



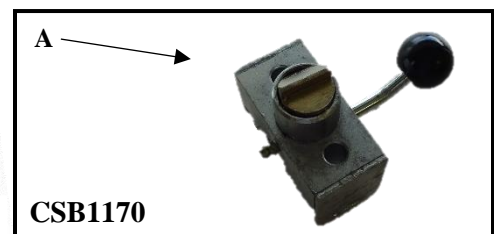
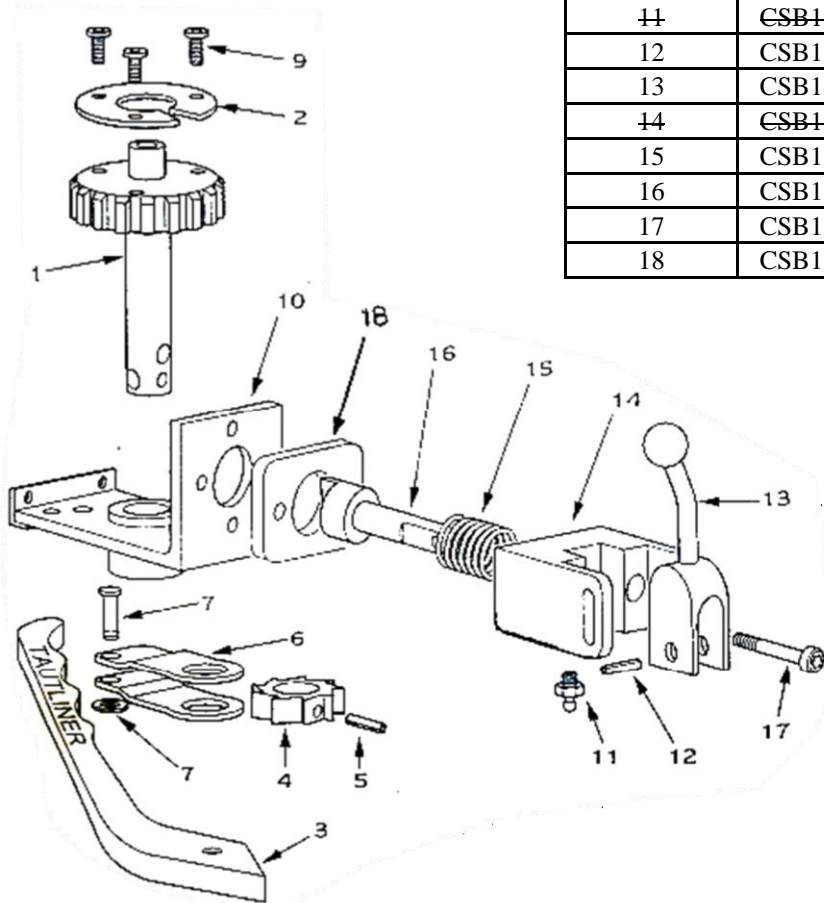

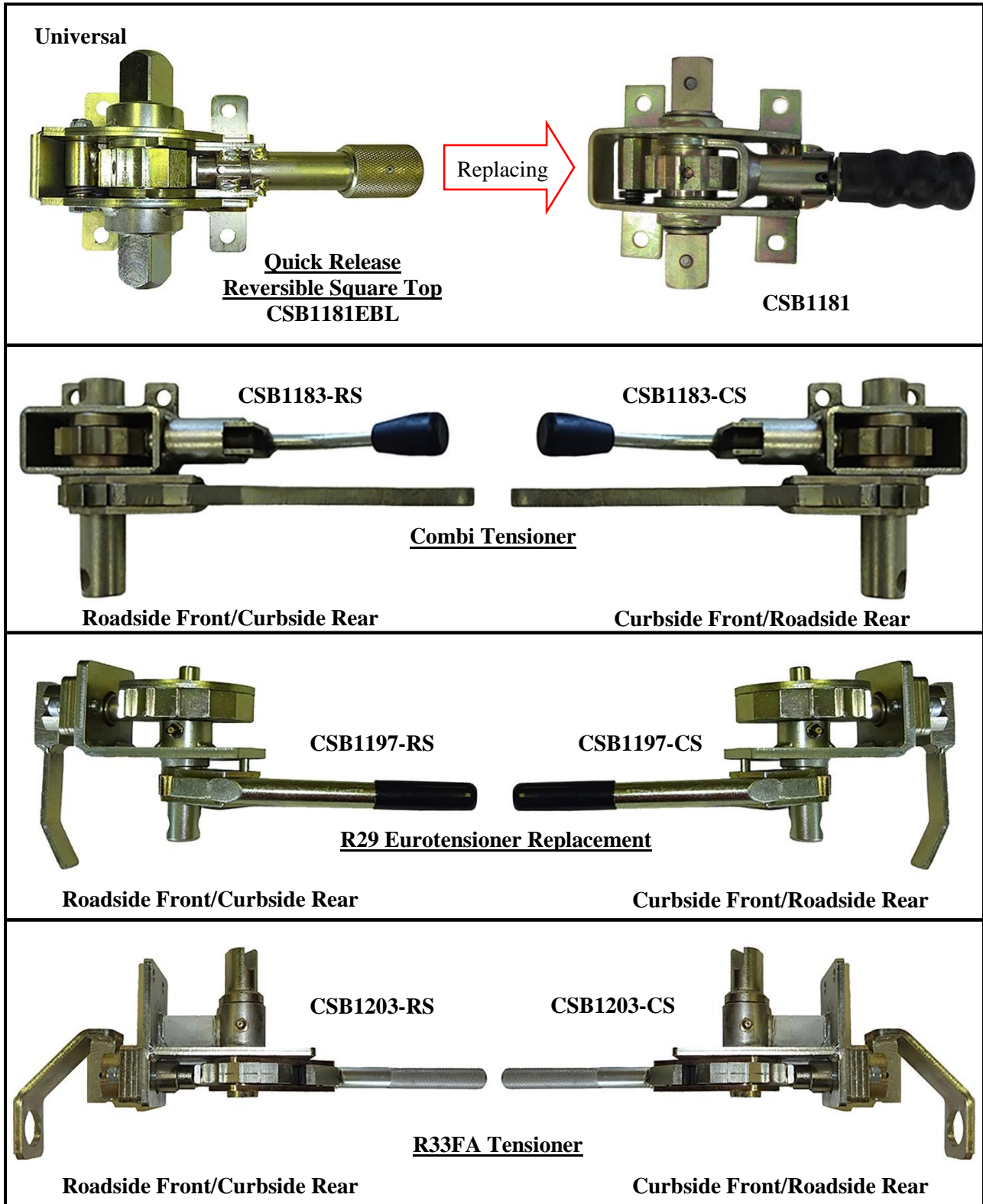

ITEM #	ORDER #	DESCRIPTION
<i>Complete Main Tensioner Assy includes the following:</i>		
discontinued	CSB1160	TENSIONER MAIN ASSEMBLY
discontinued	CSB1159	EURO TENSIONER COMPLETE
4	CSB1161	BRAKE WHEEL
2	CSB1162	TOP DISC
3	CSB1163	TENSIONER HANDLE
4	CSB1164	COG GEAR
5	CSB1165	ROLL PIN
6	CSB1166	RATCHET HANDLE HOLDER
7	CSB1167	PIN AND CIRCLIP
9	CSB1168	CAP SCREW - M8X20mm.
40	CSB1169	MAIN ANGLE BRACKET
A	CSB1170	STANDARDS PAWL ASSEMBLY
44	CSB1171	GREASE NIPPLE
12	CSB1172	ROLL PIN
13	CSB1173	PAWL HANDLE
44	CSB1174	PAWL HOUSING ORDER 01001645
15	CSB1175	PAWL SPRING
16	CSB1176	PAWL
17	CSB1177	BOLT
18	CSB1179	SPACER PLATE

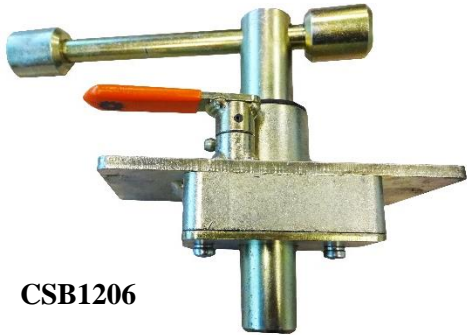
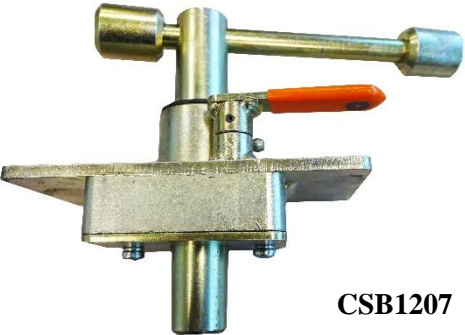

**FOR A DIRECT
REPLACEMENT OF ENTIRE
CSB1159 EUROTENSIONER,
USE CSB1197-SIDE,
SAME BOLT UP.**

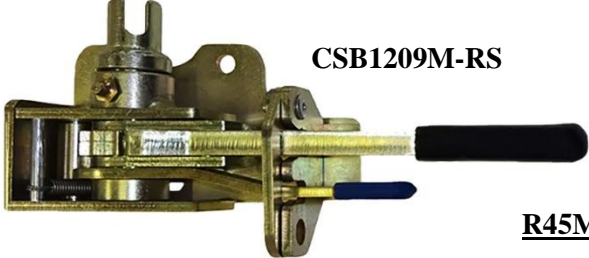
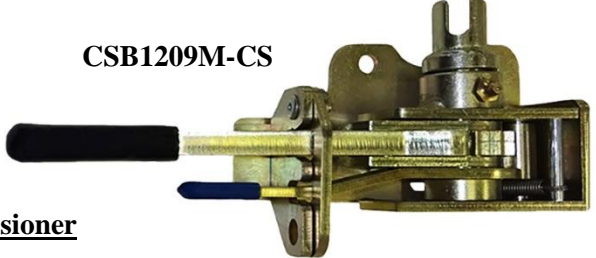

	<u>R40 – Tommy Bar</u>	
CSB1206		CSB1207
Roadside Front/Curbside Rear		Curbside Front/Roadside Rear
		<u>Lever and Pin</u> CSB1205 Replacement Part for Tommy Bar Tensioner
	<u>R44 Tensioner</u>	
CSB1208-RS		CSB1208-CS
Roadside Front/Curbside Rear		Curbside Front/Roadside Rear
	<u>R45 Tensioner</u>	
CSB1209-RS		CSB1209-CS
Roadside Front/Curbside Rear		Curbside Front/Roadside Rear
	<u>R45M Tensioner</u>	
CSB1209M-RS		CSB1209M-CS
Roadside Front/Curbside Rear		Curbside Front/Roadside Rear

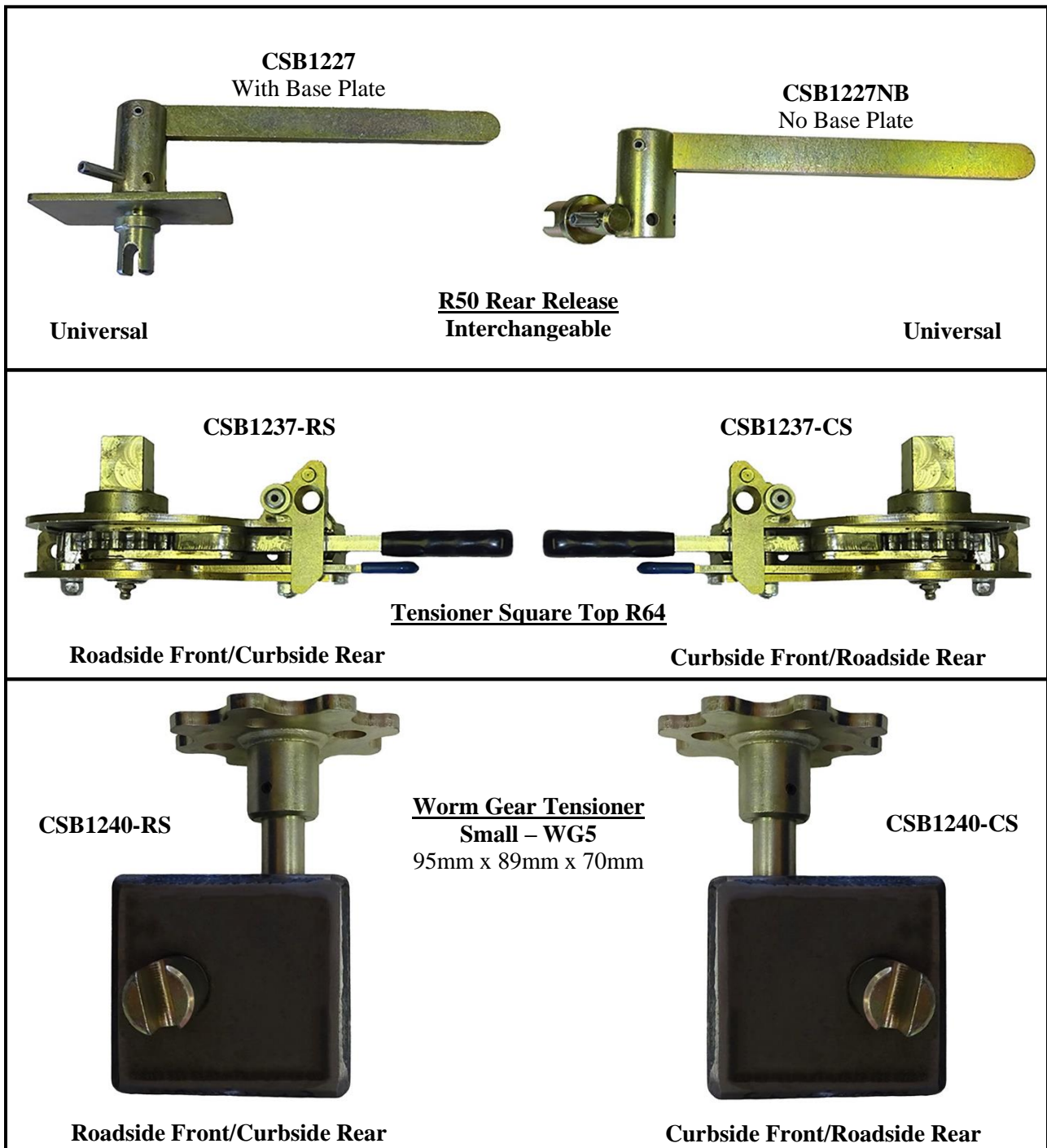

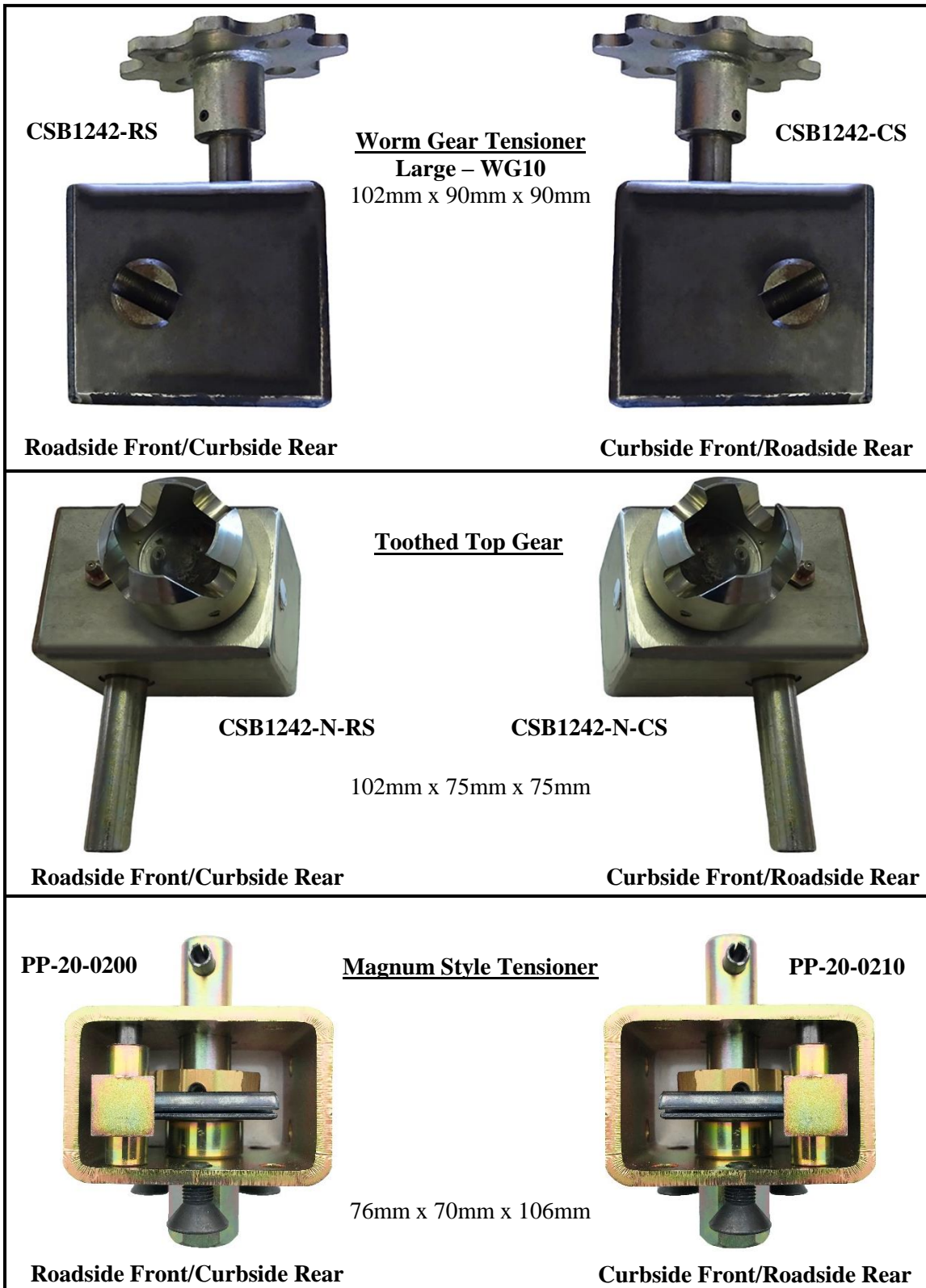

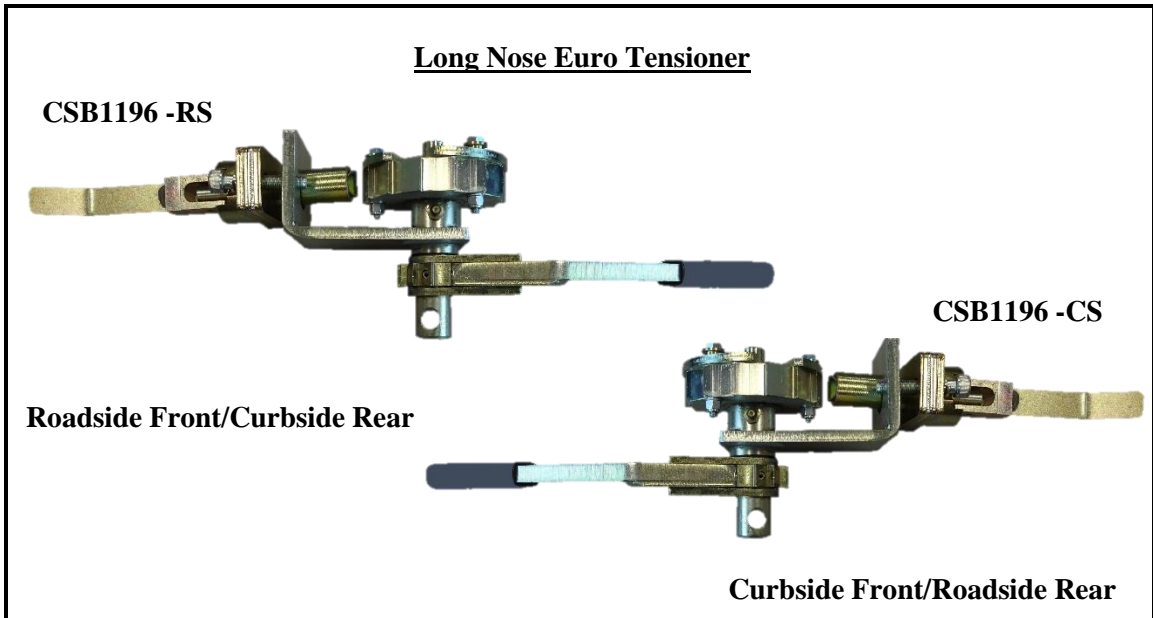



LED White Light Strips
10-10-0010
 White, 1 meter
 Includes pigtail and 3 meters adhesive tape



LED Red Light Strips
10-10-0009
 Red, 1 meter
 Includes pigtail and 3 meters adhesive tape



LED Red Micronova Light
CSB1252
 4 Diode PC Rated with
 Grommet Red

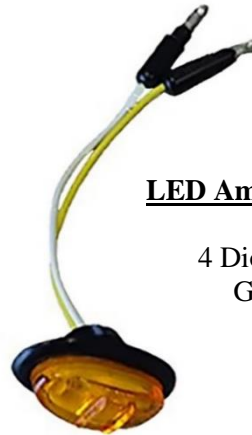

LED Amber Micronova Light
CSB1251
 4 Diode PC Rated with
 Grommet Amber



Small LED Light Work Lamp
10-10-0005
 High Intensity



Large LED Light Work Lamp
10-10-0006
 High Intensity

Eyelets, Curtain Material, and Glue

 <p><u>Eyelet Patch – 3 Hole</u> CSB1126-ASSEMBLY</p> <p>SPECIFY COLOUR</p>	 <p><u>Eyelet Patch – 1 Hole</u> CSB1125-ASSEMBLY</p> <p>SPECIFY COLOUR</p>	 <table style="margin: auto; border-collapse: collapse;"> <tr><td style="width: 80%;"></td><td style="text-align: right;">119</td></tr> <tr><td></td><td style="text-align: right;">123</td></tr> <tr><td></td><td style="text-align: right;">244</td></tr> <tr><td></td><td style="text-align: right;">370</td></tr> <tr><td></td><td style="text-align: right;">520</td></tr> <tr><td></td><td style="text-align: right;">537</td></tr> <tr><td></td><td style="text-align: right;">541</td></tr> <tr><td></td><td style="text-align: right;">586</td></tr> <tr><td></td><td style="text-align: right;">597</td></tr> <tr><td></td><td style="text-align: right;">602</td></tr> <tr><td></td><td style="text-align: right;">623</td></tr> <tr><td></td><td style="text-align: right;">636</td></tr> <tr><td></td><td style="text-align: right;">679</td></tr> <tr><td></td><td style="text-align: right;">705</td></tr> <tr><td></td><td style="text-align: right;">729</td></tr> <tr><td></td><td style="text-align: right;">763</td></tr> <tr><td></td><td style="text-align: right;">830</td></tr> <tr><td></td><td style="text-align: right;">905</td></tr> <tr><td></td><td style="text-align: right;">907</td></tr> <tr><td></td><td style="text-align: right;">911/917</td></tr> </table>		119		123		244		370		520		537		541		586		597		602		623		636		679		705		729		763		830		905		907		911/917
	119																																									
	123																																									
	244																																									
	370																																									
	520																																									
	537																																									
	541																																									
	586																																									
	597																																									
	602																																									
	623																																									
	636																																									
	679																																									
	705																																									
	729																																									
	763																																									
	830																																									
	905																																									
	907																																									
	911/917																																									
<p>NOTE: When ordering eyelet patch, specify the colour with the part number. i.e. CSB1125-119</p>																																										
 <p><u>Glue – HT66 PVC Vinyl</u> CSB1289 Pint</p>		<table style="width: 100%; border-collapse: collapse;"> <tr> <td style="width: 50%;"><u>Curtain Material</u> CSB1128 (Price per Square Foot)</td> <td style="width: 50%;"><u>Curtain Material</u> CSB1129</td> </tr> <tr> <td>CSB1128-WT (Price per Pound)</td> <td>118.5in. WIDE x LIN FT</td> </tr> <tr> <td>SPECIFY COLOUR</td> <td>SPECIFY COLOUR</td> </tr> </table>	<u>Curtain Material</u> CSB1128 (Price per Square Foot)	<u>Curtain Material</u> CSB1129	CSB1128-WT (Price per Pound)	118.5in. WIDE x LIN FT	SPECIFY COLOUR	SPECIFY COLOUR																																		
<u>Curtain Material</u> CSB1128 (Price per Square Foot)	<u>Curtain Material</u> CSB1129																																									
CSB1128-WT (Price per Pound)	118.5in. WIDE x LIN FT																																									
SPECIFY COLOUR	SPECIFY COLOUR																																									

**Our PVC curtain material comes in many different colours!
We recommend using a heat gun to repair, but if not available,
the strong, waterproof Vinyl Glue repairs as well.**



Replacement Curtains

Old Curtainsiders can be refreshed by a new pair of curtains and a coat of paint to give it an entirely revitalized look. For further improvement and versatility, parts can be replaced or updated with the latest Curtainsider advancements. Existing units from other manufacturers can be greatly improved by adding some of the desired options available at Curtainsider. Combine all this with a fast turnaround, your Curtainsider can begin a new life in short order!

Replacement curtains are available in your choice of 20+ colours and consists of 27oz. 2x2 double thread Panama weave. All of our PVC is coated both sides to meet the highest standards for durability and life expectancy.





Curtain Graphics

We also offer time tested and *proven ink graphics*, designed and applied on your colour of curtain. Graphics can be designed and applied by Curtainsider's experienced team.

For the extra impact, you can choose fully printed digital curtains.

